

Type : **EFD30-H66-1SM1**

- ✦ High Efficiency and Low Loss
- ✦ Acc. To DIN EN 62368-1
- ✦ UL94-V0 Recognized Materials
- ✦ Class 130°C Insulation System
- ✦ Operating Temperature -40°C to +100°C
- ✦ RoHS Compliant Product
- ✦ Custom Design Available



Electrical Specifications	Core Parameters	Bobbin Parameters
Max. Output Power (at 66kHz) Flyback : 45 W Half-Bridge : - - Operating Frequency : 20 - 140 kHz Isolation (pri-sec) : 3.000 Vrms, 1mA / 5 sec.	Core Type : EFD30 Effective Length (le) : 68,0 mm Effective Area (Ae) : 69,0 mm ² Effective Volume (Ve) : 4690 mm ³	Core Direction : Horizontal Number of Pins : 6+6 Max. Winding Width : 20,1 mm Max. Winding Height : 2,6 mm Winding Area : 51,3 mm ²

Dimensions [mm]

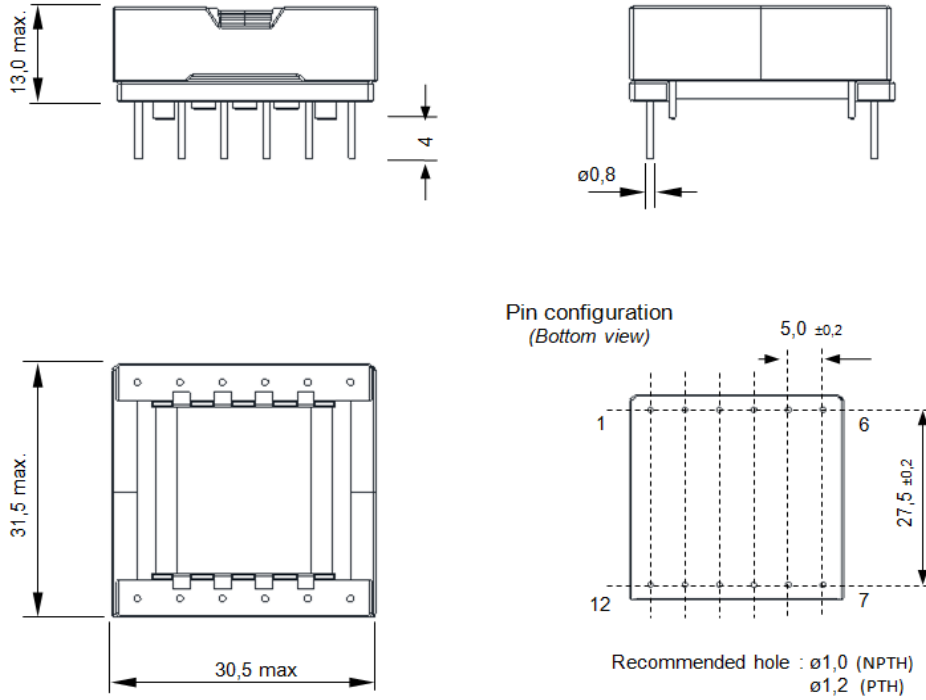

The parameters of the product are given as an example. Data are subject to change without prior notice.

Revised : 20-Jan-2022